



Vehicle History Report™

2006 LEXUS SC 430

VIN: JTHFN48Y269001229
 CONVERTIBLE
 4.3L V8 F DOHC 32V
 GASOLINE
 REAR WHEEL DRIVE



Damage reported: minor damage

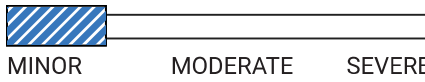

34 Service history records



4 Previous owners



Personal vehicle



106,883 Last reported odometer reading

This CARFAX Vehicle History Report is based only on information supplied to CARFAX and available as of 4/25/24 at 12:13:20 PM (CDT). Other information about this vehicle, including problems, may not have been reported to CARFAX. Use this report as one important tool, along with a vehicle inspection and test drive, to make a better decision about your next used car.



Accident / Damage History

Not all accidents / issues are reported to CARFAX

[^ Back To Top](#)

Event 1

02/08/2010

**Damage reported:
minor damage**

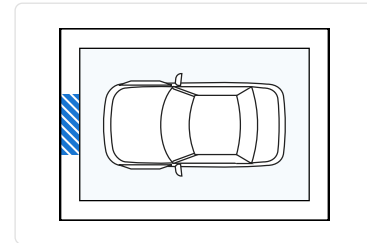
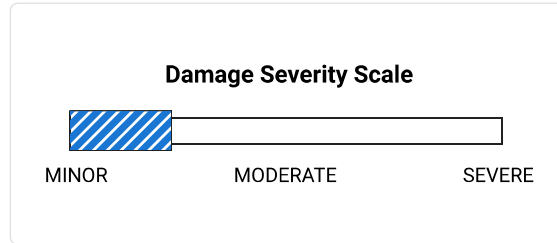

Event 2

01/26/2017

**Damage reported:
minor damage**

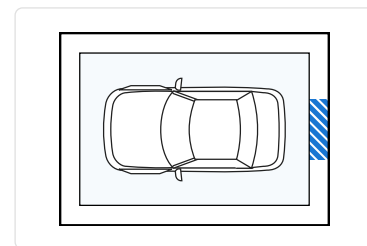
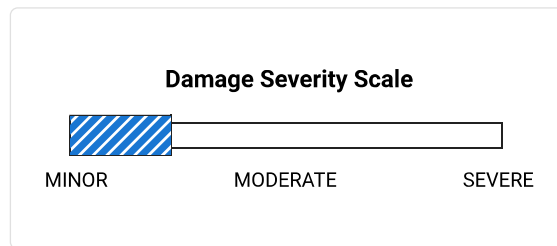

Additional History

Not all accidents / issues are reported to CARFAX

	Owners 1-2	Owner 3	Owner 4
Total Loss No total loss reported to CARFAX.	<input checked="" type="checkbox"/> No Issues Reported	<input checked="" type="checkbox"/> No Issues Reported	<input checked="" type="checkbox"/> No Issues Reported
Structural Damage CARFAX recommends that you have this vehicle inspected by a collision repair specialist.	<input checked="" type="checkbox"/> No Issues Reported	<input checked="" type="checkbox"/> No Issues Reported	<input checked="" type="checkbox"/> No Issues Reported
Airbag Deployment No airbag deployment reported to CARFAX.	<input checked="" type="checkbox"/> No Issues Reported	<input checked="" type="checkbox"/> No Issues Reported	<input checked="" type="checkbox"/> No Issues Reported
Odometer Check No indication of an odometer rollback.	<input checked="" type="checkbox"/> No Issues Indicated	<input checked="" type="checkbox"/> No Issues Indicated	<input checked="" type="checkbox"/> No Issues Indicated
Accident / Damage Damage reported: 02/08/2010 and 01/26/2017.	Minor Damage	No New Issues Reported	No New Issues Reported
Manufacturer Recall No open recalls reported to CARFAX. Check with an authorized Lexus dealer for any open recalls. View Toyota disclosure	<input checked="" type="checkbox"/> No Recalls Reported	<input checked="" type="checkbox"/> No Recalls Reported	<input checked="" type="checkbox"/> No Recalls Reported

^ Back To Top

Basic Warranty Original warranty estimated to have expired.	Warranty Expired	Warranty Expired	Warranty Expired
---	-------------------------	-------------------------	-------------------------

 Title History CARFAX guarantees the information in this section	Owners 1-2	Owner 3	Owner 4
Damage Brands Salvage Junk Rebuilt Fire Flood Hail Lemon	<input checked="" type="checkbox"/> Guaranteed No Problem	<input checked="" type="checkbox"/> Guaranteed No Problem	<input checked="" type="checkbox"/> Guaranteed No Problem
Odometer Brands Not Actual Mileage Exceeds Mechanical Limits	<input checked="" type="checkbox"/> Guaranteed No Problem	<input checked="" type="checkbox"/> Guaranteed No Problem	<input checked="" type="checkbox"/> Guaranteed No Problem



GUARANTEED - None of these title problems were reported by a U.S. state Department of Motor Vehicles (DMV). If you find that any of these title problems were reported by a DMV and not included in this report, you may qualify.
View Terms | View Certificate

 Ownership History The number of owners is estimated	Owners 1-2	Owner 3	Owner 4
Year purchased	2005	2021	2021
Type of owner	Personal	Personal	Personal
Estimated length of ownership	15 yrs. 9 mo.	2 months	2 yrs. 3 mo.
Owned in the following states/provinces	California, California	California	California
Estimated miles driven per year	See Details	---	657/yr
Last reported odometer reading	104,606	105,533	106,883

 **Detailed History**



Owner 1
Purchased: 2005



Low mileage! This owner drove less than the industry average of 15,000 miles per year.

Personal Vehicle
7,370 mi/yr

Date	Mileage	Source	Comments
09/22/2005		NICB	Vehicle manufactured and shipped to original dealer

[^ Back To Top](#)

09/27/2005	Lexus of Concord Concord, CA 925-682-3033		Vehicle serviced Pre-delivery inspection completed
	★ 4.7 / 5.0 738 Verified Reviews ❤️ 7,876 Customer Favorites		
10/12/2005	Lexus of Concord Concord, CA 925-682-3033		Vehicle serviced One tire mounted Chrome/alloy wheels installed
	★ 4.7 / 5.0 738 Verified Reviews ❤️ 7,876 Customer Favorites		
11/08/2005 101	California Motor Vehicle Dept. Crockett, CA		Title issued or updated First owner reported Titled or registered as personal vehicle Loan or lien reported
11/14/2005	Lexus of Concord Concord, CA 925-682-3033		Vehicle serviced
	★ 4.7 / 5.0 738 Verified Reviews ❤️ 7,876 Customer Favorites		
12/01/2005	Lexus of Concord Concord, CA 925-682-3033		Vehicle serviced Alignment checked Alignment performed Tires rotated Four wheel alignment performed
	★ 4.7 / 5.0 738 Verified Reviews ❤️ 7,876 Customer Favorites		
04/07/2006	Lexus of Concord Concord, CA 925-682-3033		Vehicle serviced Wheel(s) repaired
	★ 4.7 / 5.0 738 Verified Reviews ❤️ 7,876 Customer Favorites		
04/18/2006	Lexus of Concord Concord, CA 925-682-3033		Vehicle serviced 5,000 mile service performed
	★ 4.7 / 5.0 738 Verified Reviews ❤️ 7,876 Customer Favorites		

[^ Back To Top](#)

07/25/2006	Lexus of Concord Concord, CA 925-682-3033		Vehicle serviced Tire condition and pressure checked Alignment checked
	★ 4.7 / 5.0 738 Verified Reviews ❤️ 7,876 Customer Favorites		
08/25/2006	Lexus of Concord Concord, CA 925-682-3033		Vehicle serviced
	★ 4.7 / 5.0 738 Verified Reviews ❤️ 7,876 Customer Favorites		
03/16/2007	Lexus of Concord Concord, CA 925-682-3033		Vehicle serviced Tire condition and pressure checked
	★ 4.7 / 5.0 738 Verified Reviews ❤️ 7,876 Customer Favorites		
08/18/2007	Lexus of Concord Concord, CA 925-682-3033		Vehicle serviced Tire condition and pressure checked
	★ 4.7 / 5.0 738 Verified Reviews ❤️ 7,876 Customer Favorites		
10/04/2007	California Motor Vehicle Dept. Crockett, CA		Title issued or updated
04/02/2008 25,248	Lexus of Concord Concord, CA 925-682-3033		Vehicle serviced Alignment checked
	★ 4.7 / 5.0 738 Verified Reviews ❤️ 7,876 Customer Favorites		
10/15/2008 30,600	Lexus of Concord Concord, CA 925-682-3033		Vehicle serviced
	★ 4.7 / 5.0 738 Verified Reviews ❤️ 7,876 Customer Favorites		

^ Back To Top

01/06/2009 33,058

Lexus of Concord
Concord, CA
925-682-3033



Vehicle serviced

★ **4.7 / 5.0**
738 Verified Reviews
♥ **7,876** Customer Favorites

10/29/2009 42,452

Lexus of Concord
Concord, CA
925-682-3033



Vehicle serviced

GPS/Navigation module/computer reprogrammed

★ **4.7 / 5.0**
738 Verified Reviews
♥ **7,876** Customer Favorites

02/08/2010

Damage Report



Damage reported: minor damage

Damage to front



Damage Severity Scale

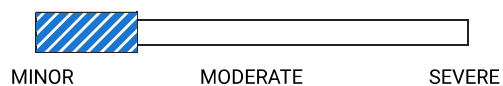



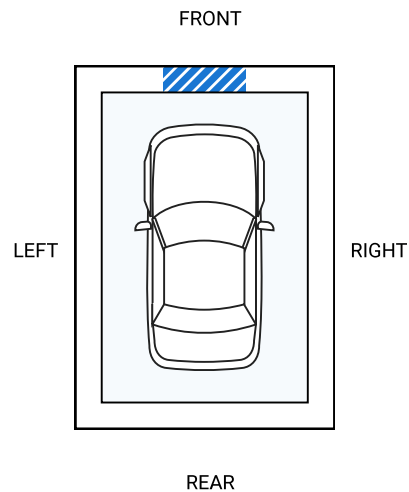

Damage Location



Minor damage is usually cosmetic, including dents or scratches to the vehicle body.

^ **Back To Top**

06/05/2010	49,599	Lexus of Concord Concord, CA 925-682-3033 ★ 4.7 / 5.0 738 Verified Reviews ♥ 7,876 Customer Favorites	 Vehicle serviced Headlights adjusted
11/02/2010	54,147	Lexus of Concord Concord, CA 925-682-3033 ★ 4.7 / 5.0 738 Verified Reviews ♥ 7,876 Customer Favorites	 Vehicle serviced Radio/sound system checked
03/30/2011	57,706	Lexus of Concord Concord, CA 925-682-3033 ★ 4.7 / 5.0 738 Verified Reviews ♥ 7,876 Customer Favorites	 Vehicle serviced Maintenance inspection completed Mirror(s) checked
11/09/2011	61,228	Lexus of Concord Concord, CA 925-682-3033 ★ 4.7 / 5.0 738 Verified Reviews ♥ 7,876 Customer Favorites	 Vehicle serviced Maintenance inspection completed Vehicle washed/detailed Interior cleaned
09/20/2012	67,390	California Inspection Station Rodeo, CA	Passed emissions inspection
12/18/2013	74,338	Lexus of Concord Concord, CA 925-682-3033 ★ 4.7 / 5.0 738 Verified Reviews ♥ 7,876 Customer Favorites	 Vehicle serviced Maintenance inspection completed Vehicle washed/detailed Alignment performed Front license plate bracket installed/ replaced Rear shock absorber(s) replaced Transmission mount(s) replaced
09/11/2014	79,172	California Inspection Station	Passed emissions inspection

[^ Back To Top](#)

08/24/2015 83,897	Lexus of Concord Concord, CA 925-682-3033		Vehicle serviced Maintenance inspection completed Right airbag assembly replaced
	★ 4.7 / 5.0 738 Verified Reviews ❤️ 7,876 Customer Favorites		
02/18/2016 85,970	Lexus of Concord Concord, CA 925-682-3033		Vehicle serviced Maintenance inspection completed Vehicle washed/detailed
	★ 4.7 / 5.0 738 Verified Reviews ❤️ 7,876 Customer Favorites		
07/23/2016 88,462	Lexus of Concord Concord, CA 925-682-3033		Vehicle serviced Maintenance inspection completed
	★ 4.7 / 5.0 738 Verified Reviews ❤️ 7,876 Customer Favorites		
09/22/2016 89,255	California Inspection Station		Passed emissions inspection
12/31/2016	Lexus of Concord Concord, CA 925-682-3033		Vehicle serviced
	★ 4.7 / 5.0 738 Verified Reviews ❤️ 7,876 Customer Favorites		
01/26/2017	Damage Report		Damage reported: minor damage Damage to rear

^ Back To Top

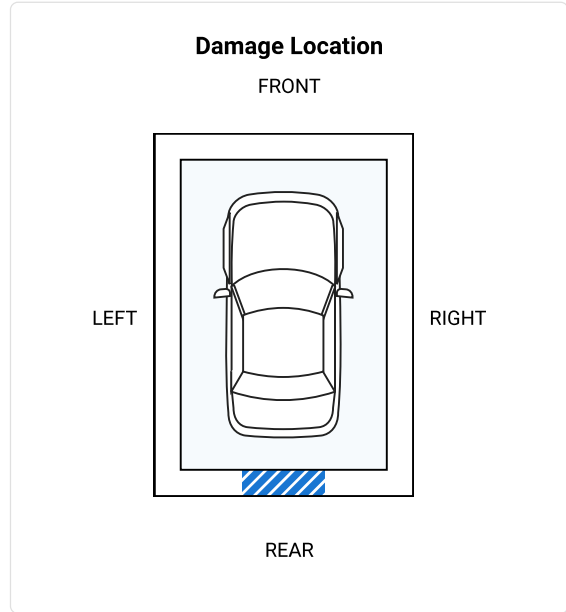
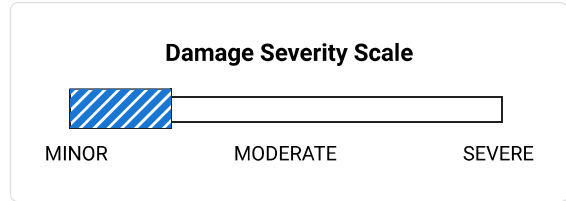

Minor damage is usually cosmetic, including dents or scratches to the vehicle body.

07/31/2017 92,319

Lexus of Concord
Concord, CA
925-682-3033

★ 4.7 / 5.0
738 Verified Reviews
❤️ 7,876 Customer Favorites



Vehicle serviced

Maintenance inspection completed

09/05/2018 94,687

California
Inspection Station

Passed emissions inspection

👤 **Owner 2**
Purchased: 2018







Low mileage! This owner drove less than the industry average of 15,000 miles per year.

Personal Vehicle
3,891 mi/yr

Date	Mileage	Source	Comments
10/12/2018		California Motor Vehicle Dept. Crockett, CA	Title issued or updated New owner reported

^ [Back To Top](#)

01/20/2020	98,344	Lexus of Concord Concord, CA 925-682-3033 ★ 4.7 / 5.0 738 Verified Reviews ❤️ 7,876 Customer Favorites	 Vehicle serviced Maintenance inspection completed Vehicle washed/detailed
09/02/2020	100,061	California Inspection Station	Passed emissions inspection
12/17/2020	102,068	Lexus of Concord Concord, CA 925-682-3033 ★ 4.7 / 5.0 738 Verified Reviews ❤️ 7,876 Customer Favorites	 Vehicle serviced Maintenance inspection completed Alignment performed Tire(s) balanced Tire(s) mounted Tires rotated
01/05/2021	102,320	Lexus of Concord Concord, CA 925-682-3033 ★ 4.7 / 5.0 738 Verified Reviews ❤️ 7,876 Customer Favorites	 Vehicle serviced Fluids checked Oil and filter changed Brake master cylinder replaced/ repaired Brake system bled Alignment performed
08/20/2021	104,557	California Inspection Station	Passed emissions inspection
08/24/2021		Lexus of Concord Concord, CA ★ 4.7 / 5.0 738 Verified Reviews ❤️ 7,876 Customer Favorites	Vehicle offered for sale
08/25/2021	104,559	Lexus of Concord Concord, CA 925-682-3033 ★ 4.7 / 5.0 738 Verified Reviews ❤️ 7,876 Customer Favorites	 Vehicle serviced Maintenance inspection completed Safety inspection performed Vehicle washed/detailed Oil and filter changed Emissions inspection performed





Looks like this dealer serviced the car in order to prepare it for sale. That's a good thing!

^ Back To Top

09/13/2021 104,606 Lexus of Concord
 Concord, CA
 925-682-3033
 ★ 4.7 / 5.0
 738 Verified Reviews
 ❤️ 7,876 Customer Favorites

Vehicle sold

 **Owner 3** Personal Vehicle
 Purchased: 2021

Date	Mileage	Source	Comments
10/07/2021		California Motor Vehicle Dept. Oakley, CA	Title issued or updated New owner reported Loan or lien reported Loan or lien released
10/20/2021	105,238	Lexus of Concord Concord, CA 925-682-3033 ★ 4.7 / 5.0 738 Verified Reviews ❤️ 7,876 Customer Favorites	 Vehicle serviced Headlights adjusted
11/16/2021		Lexus of Concord Concord, CA 925-682-3033 ★ 4.7 / 5.0 738 Verified Reviews ❤️ 7,876 Customer Favorites	 Vehicle serviced
11/23/2021		California Inspection Station	Passed emissions inspection
11/30/2021		Concord Toyota Concord, CA 925-682-7131 ★ 4.1 / 5.0 41 Verified Reviews ❤️ 2,258 Customer Favorites	 Vehicle serviced Pre-delivery inspection completed Oil and filter changed Vehicle washed/detailed Wheel(s) repaired Emissions inspection performed Emissions or safety inspection performed



Looks like this dealer serviced the car in order to prepare it for sale. That's a good thing!

^ Back To Top

12/07/2021	105,532	Concord Toyota Concord, CA ★ 4.1 / 5.0 41 Verified Reviews ♥ 2,258 Customer Favorites	Vehicle offered for sale
12/10/2021	105,533	Concord Toyota Concord, CA 925-682-7131 ★ 4.1 / 5.0 41 Verified Reviews ♥ 2,258 Customer Favorites	 Vehicle serviced
12/14/2021		Lexus of Marin San Rafael, CA ★ 4.0 / 5.0 41 Verified Reviews ♥ 1,109 Customer Favorites	Vehicle offered for sale



Owner 4
Purchased: 2021



Low mileage! This owner drove less than the industry average of 15,000 miles per year.

Personal Vehicle
657 mi/yr

Date	Mileage	Source	Comments
12/27/2021	105,684	California Motor Vehicle Dept. Santa Rosa, CA	Odometer reading reported
01/21/2022		California Motor Vehicle Dept. Santa Rosa, CA	Title issued or updated New owner reported Loan or lien reported
08/25/2022	106,258	Hammond Autowerks Santa Rosa, CA 707-538-4325 ★ 5.0 / 5.0 50 Verified Reviews ♥ 20 Customer Favorites	 Vehicle serviced Oil and filter changed Control arm(s) replaced Tire condition and pressure checked
12/15/2022		California Motor Vehicle Dept. Santa Rosa, CA	Title issued or updated Loan or lien released

^ Back To Top

10/24/2023 106,883 BNC Auto Care
Santa Rosa, CA
707-540-0248



Vehicle serviced

Emissions inspection performed

★ 4.9 / 5.0

37 Verified Reviews

♥ 7 Customer Favorites

10/24/2023

California
Inspection Station

Passed emissions inspection

Have Questions? Please visit our Help Center at www.carfax.com.



Glossary

Damage Indicator

Damage can be a result of many different types of events. Examples include contact with objects (other cars, trees, traffic signs, road debris, etc), vandalism, or weather-related events. Not every damage event is reported to CARFAX. As details about the damage event become available, those additional details are added to the CARFAX Vehicle History Report. CARFAX recommends that you have this vehicle inspected by a qualified mechanic.

- This CARFAX Vehicle History Report is based only on information supplied to CARFAX and available as of 4/25/24 at 12:13:20 PM (CDT). Other information about this vehicle, including problems, may not have been reported to CARFAX. Use this report as one important tool, along with a vehicle inspection and test drive, to make a better decision about your next used car.

Damage Severity

Damage events result in one of the following severity levels:

- **Minor:** Generally, minor damage is cosmetic (including dents or scratches), may only require reconditioning, and typically does not compromise a vehicle's operation and/or safety.
- **Moderate:** Moderate damage may affect multiple components of the vehicle and may impair the vehicle's operation and/or safety.
- **Severe:** Severe damage usually affects multiple components of the vehicle and is likely to compromise the vehicle's operation and/or safety.

CARFAX recommends getting a pre-purchase inspection at a certified collision repair facility.

First Owner

When the first owner(s) obtains a title from a Department of Motor Vehicles as proof of ownership.

Lexus Recall / Service Campaign

Portions of this report have been included under license from Toyota Motor North America, Inc. ("TOYOTA"), License Agreement TMS1013 . This data applies only to vehicle marketed or originally sold in Mexico and the United States of America, including Guam, Saipan, American Samoa, Puerto Rico, the U.S. Virgin Islands and the other United States territories and protectorates with currently open safety or emissions recalls, or service campaigns. While TOYOTA provides data to Carfax Inc. on a regular basis, this report may not include very recent activity. For the manufacturer's most current information on recall/campaign activity for any Toyota, Lexus or Scion brand vehicle, you must go to <http://toyota.com/recall> or <http://lexus.com/recall>..

New Owner Reported

When a vehicle is sold to a new owner, the Title must be transferred to the new owner(s) at a Department of Motor Vehicles.

Ownership History

CARFAX defines an owner as an individual or business that possesses and uses a vehicle. Not all transactions represent changes in ownership. To provide estimated number of owners, CARFAX technology analyzes all the events in a vehicle history. Estimated ownership is available for ven...

^ Back To Top

manufactured after 1991 and titled solely in the US including Puerto Rico. Dealers sometimes opt to take ownership of a vehicle and are required to in the following states: Maine, Massachusetts, New Jersey, Ohio, Oklahoma, Pennsylvania and South Dakota. Please consider this as you review a vehicle's estimated ownership history.

Title Issued

A state issues a title to provide a vehicle owner with proof of ownership. Each title has a unique number. Each title or registration record on a CARFAX report does not necessarily indicate a change in ownership. In Canada, a registration and bill of sale are used as proof of ownership.

Follow Us:[facebook.com/CARFAX](https://www.facebook.com/CARFAX)[@CARFAXinc](https://twitter.com/CARFAXinc)[About CARFAX](#)

CARFAX DEPENDS ON ITS SOURCES FOR THE ACCURACY AND RELIABILITY OF ITS INFORMATION. THEREFORE, NO RESPONSIBILITY IS ASSUMED BY CARFAX OR ITS AGENTS FOR ERRORS OR OMISSIONS IN THIS REPORT. CARFAX FURTHER EXPRESSLY DISCLAIMS ALL WARRANTIES, EXPRESS OR IMPLIED, INCLUDING ANY IMPLIED WARRANTIES OF MERCHANTABILITY OR FITNESS FOR A PARTICULAR PURPOSE.

© 2024 CARFAX, Inc., part of S&P Global. All rights reserved.

4/25/24 12:13:20 PM (CDT)

[^ Back To Top](#)